

10.4" Fanless Embedded Touch Panel PC

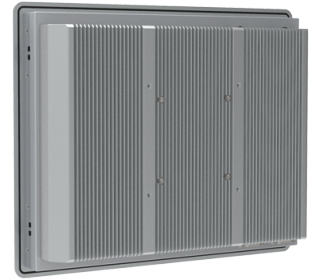

Dimensional Outline: 10.4" Fanless Embedded Touch Panel PC

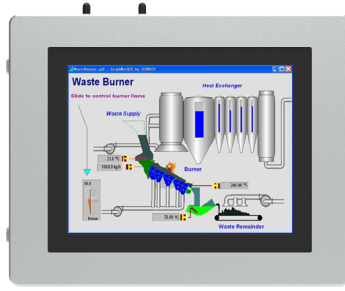
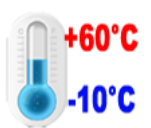
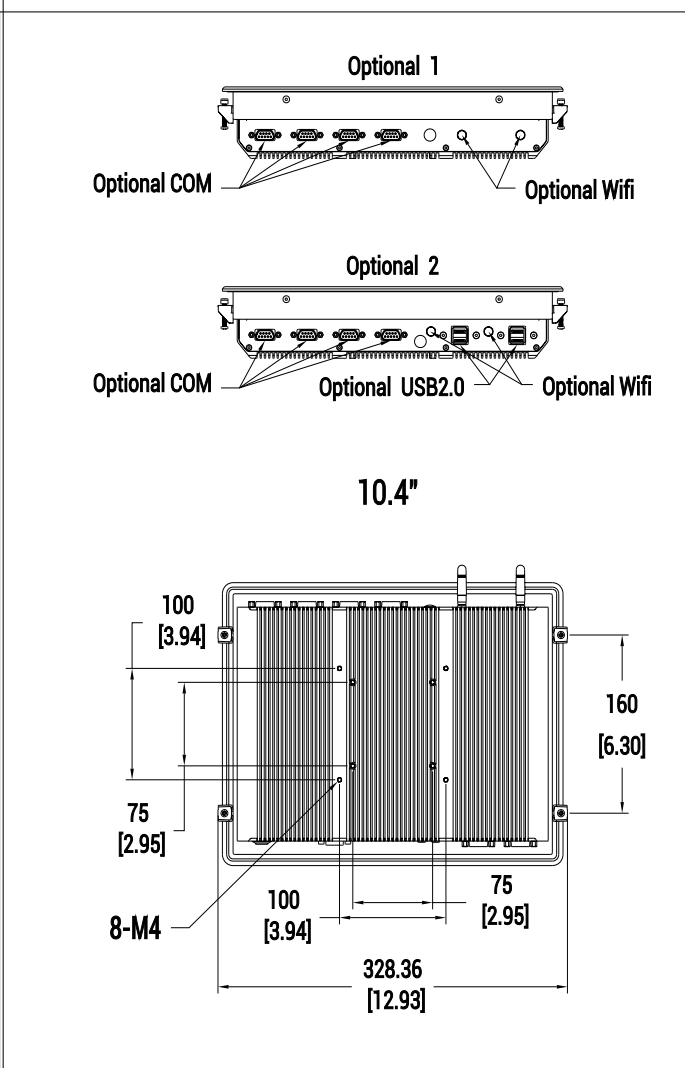
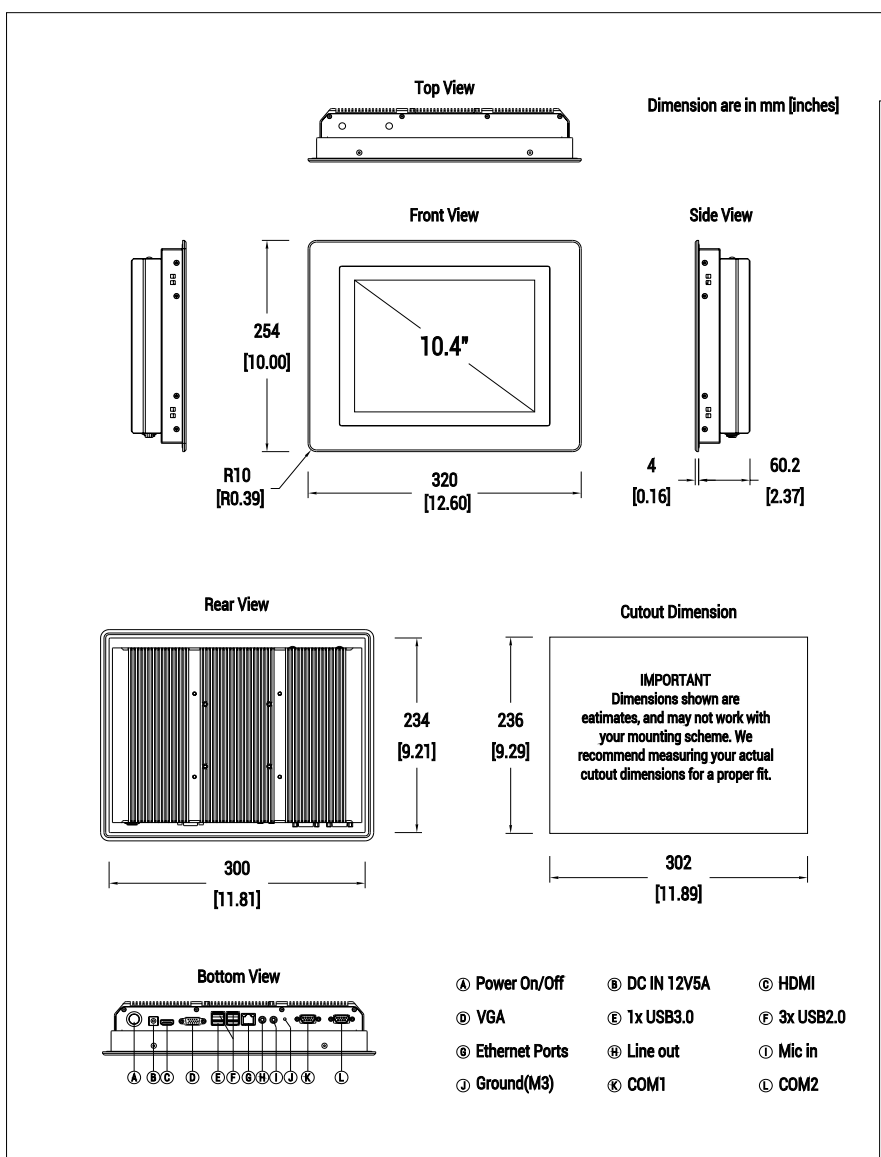

Model: NETPC310/410

Description	Product Name	10.4" Fanless Embedded Touch PC					
Item	Model Number	NETPC310/410 (310 Series for Resistive touch; 410 for Capacitive touch)					
Display	Screen size(inch)	10.4" TFT-LCD					
	Aspect Ratio	4:3 (H:V)					
	Physical resolution	1024*768					
	LED Color	262K					
	Luminance (cd/m2)	470					
	Contrast Ratio	3000:1					
	Viewing Angle (H-V)	89/89/89/89					
	Backlight	LED					
	Backlight Lifetime (hrs)	LED / 30,000					
Touch Panel	Touch Type	5-wire resistive touch Or Projected Capacitive 10-Point Multitouch					
	Touch Controller	USB Interface					
System	CPU Option	Intel® Celeron Dual Core J1800 2.4 GHz	Intel® Celeron QuadCore J1900, 2.0 GHz	Intel® Celeron dual Core 3855U, 1.6 GHz (Gen 6th)	Intel® Core i3-6006U/i3-7020u 2.0/2,3GHz, dual core (Gen 6th/7th)	Intel® Core i5-6200U/i5-7200U 2.3/2.5GHz, dual core (Gen 6th/7th)	Intel® Core i7-6500U/i7-7500U 2.5/2.7GHz, dual core (Gen 6th/7th)
	Chipset	Intel Bay trail	Intel Bay trail	Intel Skylake	Intel Skylake/Kabylake	Intel Skylake/Kabylake	Intel Skylake/Kabylake
	Graphic GPU	Intel® HD Graphics					
	RAM/Memory	Standard: 4GB 1*DDR3L SODimm (MAX 8GB)			Standard: 4GB (2*DDR3 SODIMM MAX.16G)		
	Storage	Standard: Industrial 32GB SSD (Could be upgradable)					
	Ethernet/LAN	1xLAN or 2x LAN 1000Mbit RJ45 Ports					
	Audio	1 X 3.5 mmLine Out1 X 3.5 mm Mic In					
	Operating System	Ubuntu; Win7/8/10; Linux; 32Bit/64Bit					
	Pre-installed OS	Linux Ubuntu					
	I/O Ports	USB Ports	J1800/J1900 4 USB version: 3.0x 1; 2.0x 3 6 USB version: 3.0x 1; 2.0x 5		3855/i3/i5/i7 4 USB version: 3.0x 2 + 2.0x 2 6 USB version: 3.0x 2 + 2.0x 4 (could customize 4x 3.0; 2x 2.0)		
Serial Ports		2x COM or 6x COM ports Full-PIN (RS232; 5V/12V) (default)					
VGA		1x VGA Connector					
HDMI		1xHDMI Connector					
Audio		MIC-In, EAR-Out					
Power		100-240V ACDC active switching adaptor; 1x 12V DC-In					
Mechanical		Construction	Aluminum cooling cover and metal enclosure				
	House Dimension (mm) W x H x D	320*254*64.2mm					
	Operating Temperature	-10 ~ +50 °C					
	Storage Temperature	-20~ +60 °C					
	Humidity Range (RH)	10% - 90%					
	Mounting	Embedded; VESA 75/100mm					
	Net weight (kg)	3.5kg					
	Gross weight (kg)	5.0kg(incl. carton)					
	Protect	IP66 Front panel; Withstanding water, moisture, dust and vibration					
Certification	CE/FCC/RoHS						
Included in the Delivery	Power adapter;Short Installation Manual; 2x Wifi antenna(Optional)						
Order Option:	*RAM/Memory	4GB standard, 8GB (MAX for J1800/1900), 16GB					
	*SSD Storage	32GB SSD standard, 64GB, 128GB,256GB,512GB					
	*HDD Storage	500GB HDD, 1T HDD, 2T HDD					
	*Additional WI-Fi	WIFI includes bluetooth(two-in-one)					
	*Optional COM	1X RS422 /1X RS485 COM					



To meet the different needs of customers, Wisemaker offer various interfaces solutions for option.

Option A: One LAN+ 4x USB+ 2x RS232 COM



Bottom View

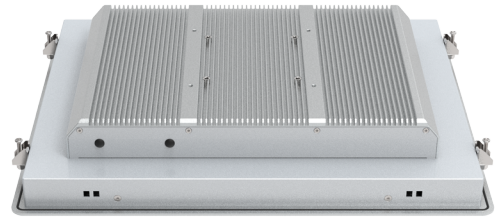

Top View

Option B: One LAN+ 4x USB+ 6x RS232 COM



Bottom View



Top View

Option C: Dual LAN+ 6x USB+ 6x RS232 COM



Bottom View



Top View

Note: Wifi is optional for A,B,C.
RS232 COM default, could choose 1x RS422/ 1x RS485 COM

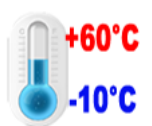

Our slim Panel pcs include fanless or fan for option, if the panel pc need to be applied in a tough high temperature surroundings, you could choose panel pc with fan installed in the outer side, the fan could be detachable, easy maintenance.

Fan Series View for different sizes:

10.4" & 12.1" Fan series, interfaces optional (see the above optional interfaces section)



15" 17" 19" Fan series, interfaces optional (see the above optional interfaces section)

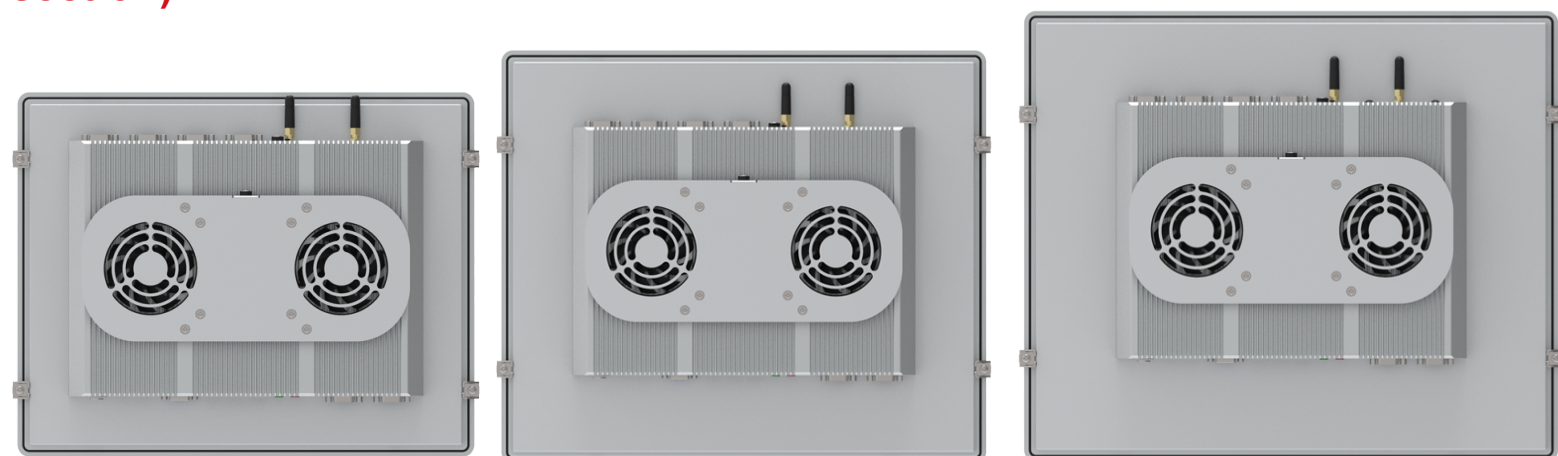

Fan comes with the power cord, and could be detachable.